

# VICKERS®

## Check Valves



C2-8\*\*, C5G(V)-8\*\* and DT8P1

### Typical Section

Model C5G(V)-8\*\* shown with subplate

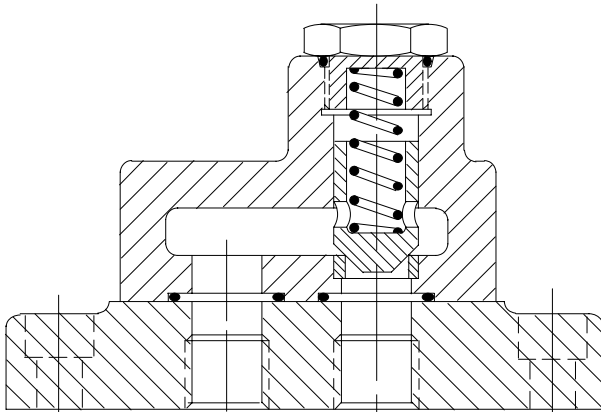

### Functional Symbols

(a) Check valve  
 Models C2-8\*\*-(S3)  
 C2-8\*\*-S8  
 C5G(V)-8\*\*-(S3)  
 C5G(V)-8\*\*-S8  
 DT8P1-\*\*-\*\*



(b) Check valve with bypass flow restrictor

Models C2-8\*\*-S12  
 C5G(V)-8\*\*-S12

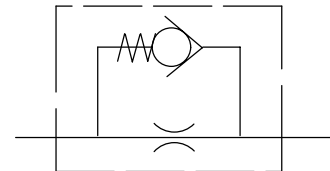

### Basic Characteristics

Type ..... Poppet valves  
 Mounting:  
 C2-8\*\* and DT8P1 ..... Pipe thread  
 C5G(V)-8\*\* ..... Subplate  
 Maximum flow ..... Up to 380 L/min  
 (100 USgpm)  
 Cracking pressure ..... Up to 5,2 bar  
 (75 psi)  
 Maximum pressure ..... Up to 350 bar  
 (5000 psi)

### General Description

The directly operated, angled, gasket mounted and inline check valves described in this leaflet are used in hydraulic systems where check valves, which are closed by a limited spring force, are required allowing oil flow in one direction only.

Various cracking pressures are available depending on the rating of the spring used. All models, except the inline check valves, can be used for a variety of flow conditions including high velocity flows resulting in shock conditions. Inline models are intended for low shock service.

An option on the C5G and C2 valves allows for a hole to be drilled in the poppet to provide a small return flow when the valve is closed



# Model Codes

## Pipe-Mounted, Angle Models, C2-8\*\* Series

**(F3-) C2 - \*\*\* - (S\*\*) - UB**

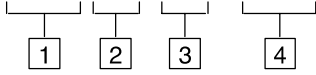

**1 Special seals**

For use with phosphate ester type fluids  
Omit if not required

**2 Design number**

Subject to change

**3 Nominal size**

(Nominal bore pipe size)

800 = 1/4"

805 = 3/8"

815 = 3/4"

820 = 1"

825 = 1 1/4"

830 = 1 1/2"

**4 Cracking pressure**

S3 = 3,5 bar (50 psi)

S8 = 5,2 bar (75 psi)

S12 = 0,35 bar (5 psi), with threaded plug in poppet for purchaser to drill through to provide small flow restriction in closed condition

Blank = 0,35 bar (5 psi)

## Pipe-Mounted, In-Line Models, DT8P1 Series

**DT8P1 - \*\* - \*\* - \*\* - \*\***

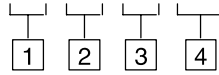

**1 Nominal size**

02 = 1/4"

03 = 3/8"

06 = 3/4"

10 = 1 1/4"

**2 Cracking pressure**

05 = 0,35 bar (5 psi)

30 = 2,1 bar (30 psi)

65 = 4,5 bar (65 psi)

**3 Design number**

10 for sizes 02 and 03

11 for sizes 06 and 10

Subject to change. Installation dimensions remain unchanged for design numbers 10-19 inclusive.

**4 Port threads**

For sizes 02 and 03 only:

UB = G (BSPF)

For sizes 06 and 10 only:

ENB = G (BSPF)

## Subplate Mounted Models, C5G (V)-8\*\* Series

**(F3-) C 5 G (V) - 8\*\* - (S\*\*)**

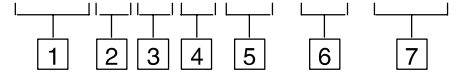

**1 Special seals**

For use with phosphate ester type fluids  
Omit if not required

**2 Check valve**

**3 Design number**

Subject to change

**4 Gasket mounting**

**5 Pressure rating**

V = 350 bar (5000 psi),

C5GV-815/825 models

Omit for 250 bar (3600 psi), C5G-805 models

**6 Nominal size**

(nominal bore pipe size)

805 = 3/8"

815 = 3/4"

825 = 1 1/4"

**7 Cracking pressure**

S3 = 3,5 bar (50 psi)

S8 = 5,2 bar (75 psi)

S12 = 0,35 bar (5 psi), with threaded plug in poppet for purchaser to drill through to provide small flow restriction in closed condition

Omit for 0,35 bar (5 psi)

**Subplates**

See "Installation Dimensions" section

**Fixing Bolt Kits**

See "Installation Data" section

# Operating Data

## Maximum Operating Pressure, bar (psi)

C5G-805 valves	250 (3600)
C5GV-815/825 valves	350 (5000)
All other valves	210 (3000)
E-C4GM-815 subplates	210 (3000)
E-C5GM-825 subplates	210 (3000)

## Cracking Pressure, bar (psi)

C2-8**	0,35 (5)
C2-8**-S3	3,5 (50)
C2-8**-S8	5,2 (75)
C2-8**-S12	0,35 (5)
C5G(V)-8**(-S12)	0,35 (5)
C5G(V)-8**-S3	3,5 (50)
C5G(V)-8**-S8	5,2 (75)
DT8P1**-05	0,35 (5)
DT8P1**-30	2,1 (30)
DT8P1**-65	4,5 (65)

## Nominal Flow, L/min (USgpm)

C2-800-(S**)	12 (3)
C2-805-(S**)	23 (6)
C2-815-(S**)	60 (16)
C2-820-(S**)	105 (28)
C2-825-(S**)	170 (45)
C2-830-(S**)	245 (65)
C5G-805-(S**)	38 (10)
C5GV-815-(S**)	76 (20)
C5GV-825-(S**)	380 (100)
DT8P1-02-**	12 (3)
DT8P1-03-**	30 (8)
DT8P1-06-**	76 (20)
DT8P1-10-**	190 (50)

## Hydraulic Fluids

The C2 and C5G(V) models can be used with hydraulic oils, water-in-oil emulsions and water glycols. Add prefix "F3" to model designation when phosphate ester (not alkyl-based) are to be used.

DT8P1 models can be used with all of the above mentioned fluids.

The extreme operating viscosity range is from 13 to 860 cSt (70 to 4000 SUS) but the recommended range is 13 to 54 cSt (70 to 245 SUS).

For further information about fluids see leaflet 920.

## Contamination Control Requirements

Recommendations on contamination control methods and the selection of products to control fluid condition are included in Vickers publication 9132 or 561, "Vickers Guide to Systemic Contamination Control". The book also includes information on the Vickers concept of "ProActive Maintenance". The following recommendations are based on ISO cleanliness levels at 2 µm, 5 µm and 15 µm. For products in this catalog the recommended levels are:

Up to 210 bar (3000 psi)	20/18/15
Above 210 bar (3000 psi)	20/18/15

## Temperature Limits

### Ambient

Min.	-20°C (-4°F)
Max.	+70°C (+158°F)

## Fluid Temperature

	Petroleum oil	Water-containing
Min.	-20°C (-4°F)	+10°C (50°F)
Max.*	+80°C (+176°F)	+54°C (130°F)

\* To obtain optimum service life from both fluid and hydraulic system 65° C (150° F)

normally is the maximum temperature except for water-containing fluids.

For synthetic fluids consult manufacturer or Vickers representative where limits are outside those for petroleum oil. Whatever the actual temperature range, ensure that viscosities stay within the limits specified in the "Hydraulic Fluids" section.

## Pressure Drop

### Models C5G(V)-8\*\*

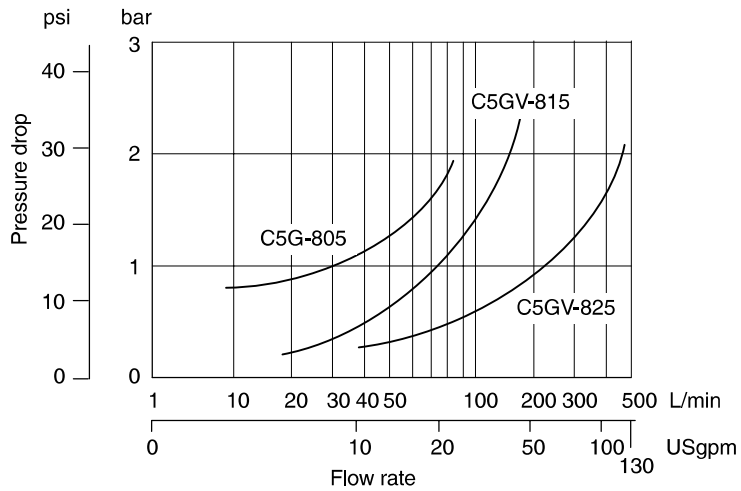

### Models DT8P1

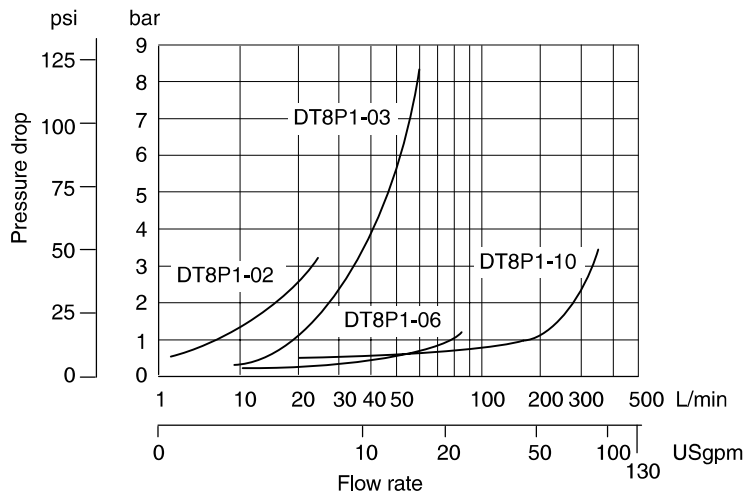

### Models C2-8\*\*

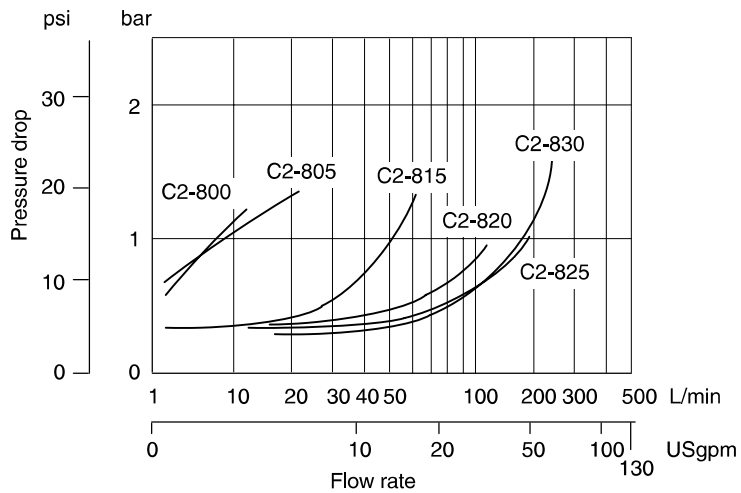

# Installation Dimensions in mm (inches)

## Model C5G(V)-8\*\*

Note: For C5G-805 models, users must provide a machined pad (bound by dimensions "A" and "B") for mounting. Surface flatness within 0,01 mm per 100 mm (0.0001" per 1") and smooth within 0,8 µm (32 µin).

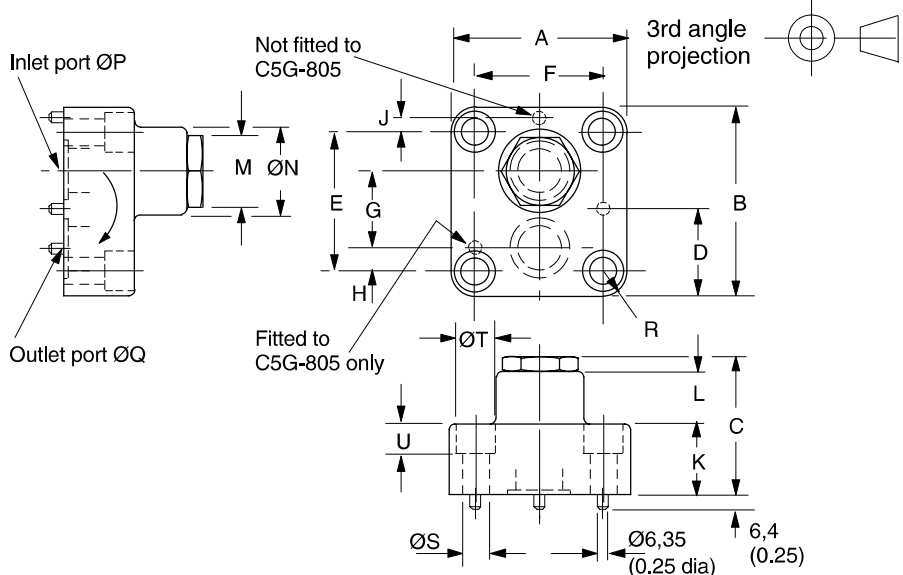

Model	A	B	C	D	E	F	G	H	J	K	L	M	N	P	Q	R	S	T	U
C5G-805	65 (2.56)	77,7 (3.06)	66 (2.6)	38,9 (1.53)	60,5 (2.38)	47,8 (1.88)	35,1 (1.38)	12,7 (0.5)	-	33,3 (1.31)	29,5 (1.16)	-	33,3 (1.31)	14,7 (0.58)	14,7 (0.58)	8,6 (0.34)	10,7 (0.42)	-	-
C5GV-815	97 (3.82)	113 (4.45)	76 (2.99)	56,4 (2.22)	81 (3.19)	65 (2.56)	46 (1.81)	12,7 (0.5)	8,7 (0.34)	38 (1.5)	27 (1.06)	41,1 (1.62)	51 (2.0)	19,0 (0.75)	22,2 (0.87)	16 (0.63)	16,7 (0.66)	25,4 (1.0)	16 (0.63)
C5GV-825	127 (5.0)	127 (5.0)	110 (4.33)	63,5 (2.5)	92 (3.62)	92 (3.62)	50,8 (2.0)	20,6 (0.81)	9,5 (0.37)	58 (2.28)	42 (1.65)	47,7 (1.87)	66,5 (2.62)	28,6 (1.13)	35,0 (1.38)	17,5 (0.69)	20,8 (0.82)	30,1 (1.18)	-

**Subplate** (Max. op. pressure 210 bar (3000 psi))  
(Not available for C5G-805 valves)

For pressures above 210 bar (3000 psi) or when the tabled subplates are not required, a machined pad (bound by the shaded area) must be provided for mounting.

Surface flatness within 0,01 mm per 100 mm (0.0001" per 1") and smooth within 0,8 µm (32 µin).

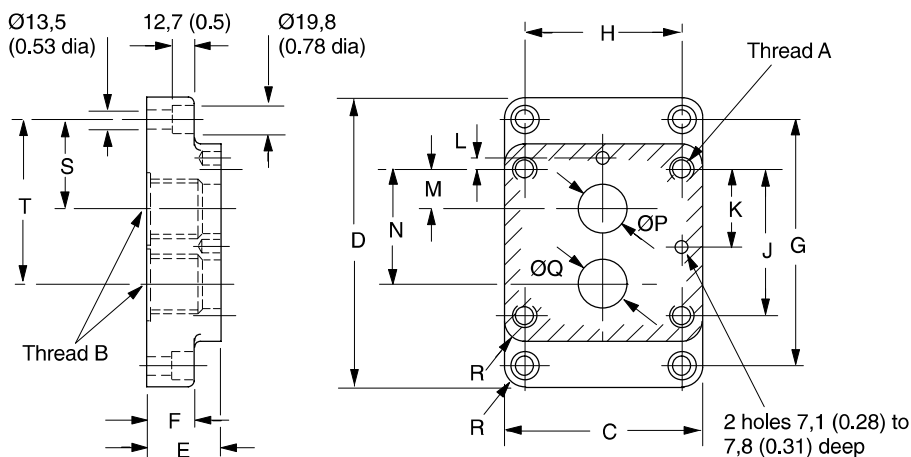

Subplate	Thread A	Thread B	C	D	E	F	G	H	J	K
E-C4GM-815-R	M16-6H	G 3/4" (BSPF)	97	172	28,4	25,4	139,7	65,0	81,0	40,5
E-C4GM-815-B	5/8" - 11 UNC-2B	G 3/4" (BSPF)	(3.82)	(6.77)	(1.12)	(1.0)	(5.5)	(2.26)	(3.12)	(1.59)
E-C5GM-825-R	M20-6H	G 1 1/4" (BSPF)	127	187	47,6	22,2	152,4	92,0	92,0	46,0
E-C5GM-825-B	3/4" - 10 UNC-2B	G 1 1/4" (BSPF)	(5.0)	(7.36)	(1.87)	(0.87)	(6.0)	(3.62)	(3.62)	(1.81)

Subplate	L	M	N	P	Q	R	S	T
E-C4GM-815-R	8,7 (0.34)	22,2 (0.87)	68,3 (2.69)	22,2 (0.87)	22,2 (0.87)	16 (0.63)	50,6 (1.99)	98,7 (3.89)
E-C4GM-815-B								
E-C5GM-825-R	9,5 (0.37)	20,6 (0.81)	71,4 (2.81)	28,6 (1.13)	35,0 (1.38)	17,56 (0.69)	21,2 (0.83)	69,3 (2.72)
E-C5GM-825-B								

**Model C2-8\*\***

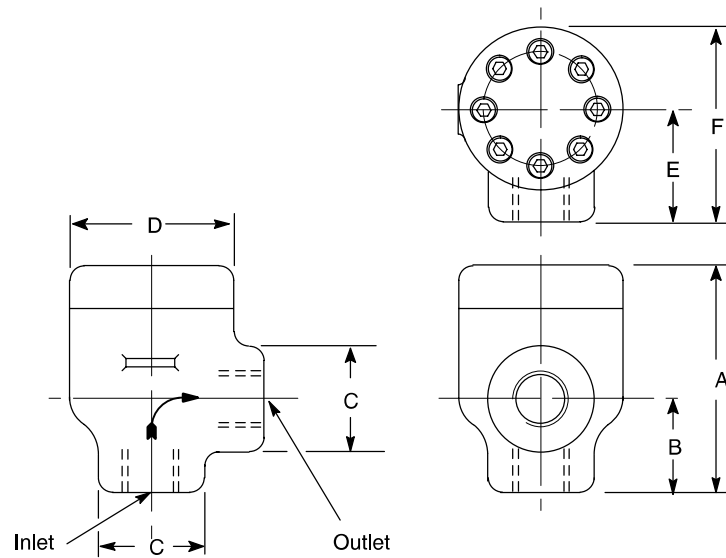

Model	A	B	C	D	E	F	Port threads (BSPF)
C2-800	75 (2.95)	26 (1.02)	32 (1.26)	54 (2.13)	32 (1.26)	58 (2.28)	G 1/4"
C2-805	75 (2.95)	26 (1.02)	32 (1.26)	54 (2.13)	32 (1.26)	58 (2.28)	G 3/8"
C2-815	98 (3.86)	44,5 (1.75)	61 (2.4)	70 (2.76)	46 (1.81)	81 (3.19)	G 3/4"
C2-820	116 (4.57)	47 (1.85)	57 (2.24)	83 (3.27)	57 (2.24)	98 (3.86)	G 1"
C2-825	138 (5.43)	67 (2.64)	76 (2.99)	83 (3.27)	67 (2.64)	108 (4.25)	G 1 1/4"
C2-830	138 (5.43)	67 (2.64)	76 (2.99)	83 (3.27)	67 (2.64)	108 (4.25)	G 1 1/2"

**Model DT8P1**

CAUTION: DT8P1 models are designed for low-shock closure service; for high-shock closure use the equivalent size of C2-8\*\* model shown above.

Model	A	B	Port threads (BSPF)
DT8P1-02	57,2 (2.25)	22,2 (0.87)	G 1/4"
DT8P1-03	76,2 (3.0)	25,4 (1.0)	G 3/8"
DT8P1-06	98,4 (3.87)	38,1 (1.5)	G 3/4"
DT8P1-10	133,4 (5.25)	63,5 (2.5)	G 1 1/4"

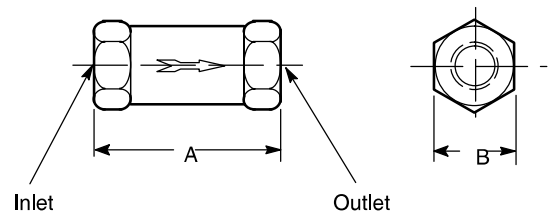

---

## Mass, kg (lb)

C2-800 .....	1,4 (3.1)
C2-805 .....	1,4 (3.1)
C2-815 .....	2,3 (5.1)
C2-820 .....	3,7 (8.1)
C2-825 .....	4,8 (10.6)
C2-830 .....	4,8 (10.6)
C5G-805 .....	1,3 (2.9)
C5GV-815 .....	3,0 (6.6)
C5GV-825 .....	6,2 (13.6)
DT8P1-02 .....	0,2 (0.5)
DT8P1-03 .....	0,3 (0.7)
DT8P1-06 .....	0,7 (1.6)
DT8P1-10 .....	2,8 (6.2)

## Installation Data

Mounting attitude optional.

### Valve Fixing Bolts

Recommended bolt kit options are listed below. If bolts are to be provided by the user they must be to Class 12,9 (ISO 898) or equivalent.

Valve	Subplate	Bolt kit
C5G-805	–	BKCG-805-619▲
C5GV-815	E-C4GM-815-R	EBKCG-815-612M
	E-C4GM-815-B	BKCG-815-612
C5GV-825	E-C5GM-825-R	EBKCG-825-616M
	E-C5GM-825-B	BKCG-825-616

▲  $\frac{3}{8}$ "-16 UNC

## Ordering Procedure

Subplates and bolt kits are supplied as separate units and therefore must be ordered as such.